

TWO-WAY COMPONENT SPEAKER SYSTEM



MS-52C
MS-62C



OWNER'S MANUAL



by HARMAN



MS-52C



MS-62C

SPECIFICATIONS	MS-52C	MS-62C
Nominal impedance:	4 ohms	4 ohms
Continuous power handling:	80 W	80 W
Peak power handling:	320 W	320 W
Frequency response:	70 Hz - 20 kHz	60 Hz - 20 kHz
Sensitivity (2,83 V/m):	88 dB	89 dB

Warning: Playing loud music in an automobile can permanently damage your hearing as well as hinder your ability to hear traffic. We recommend listening at low levels while driving. We accept no liability for hearing loss, bodily injury or property damage resulting from use or misuse of this product.

General care: the loudspeaker grilles may be cleaned with a damp cloth. Do not use cleaners or solvents of any kind on the grilles, speaker cones or tweeter domes.

Warranty: MS speakers are warranted against defects. The duration of the speaker's warranty depends on the laws in the country where the speaker was purchased. Your local JBL car audio retailer can help you determine the length of your warranty. To register your product online, please visit www.JBL.com.

DIMENSIONS

MS-52C

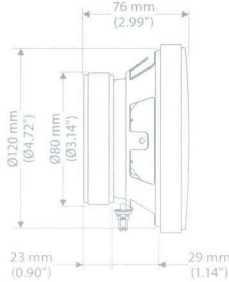
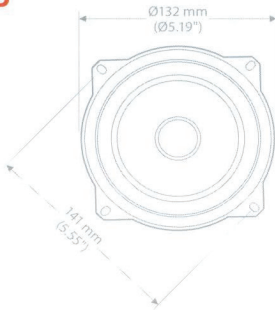

CROSSOVER

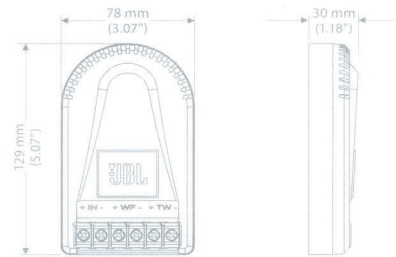

MS-62C

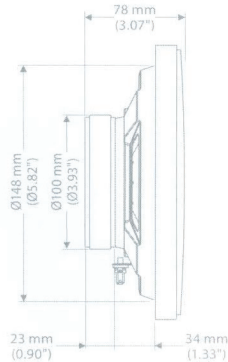
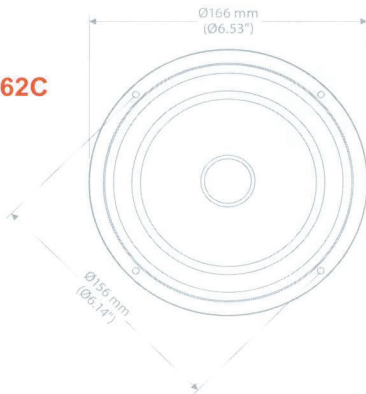

TWEETER

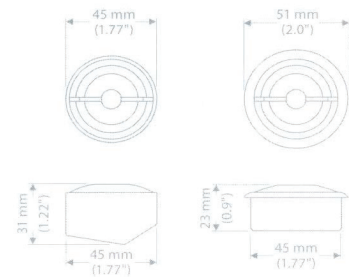

MS-52C & MS-62C

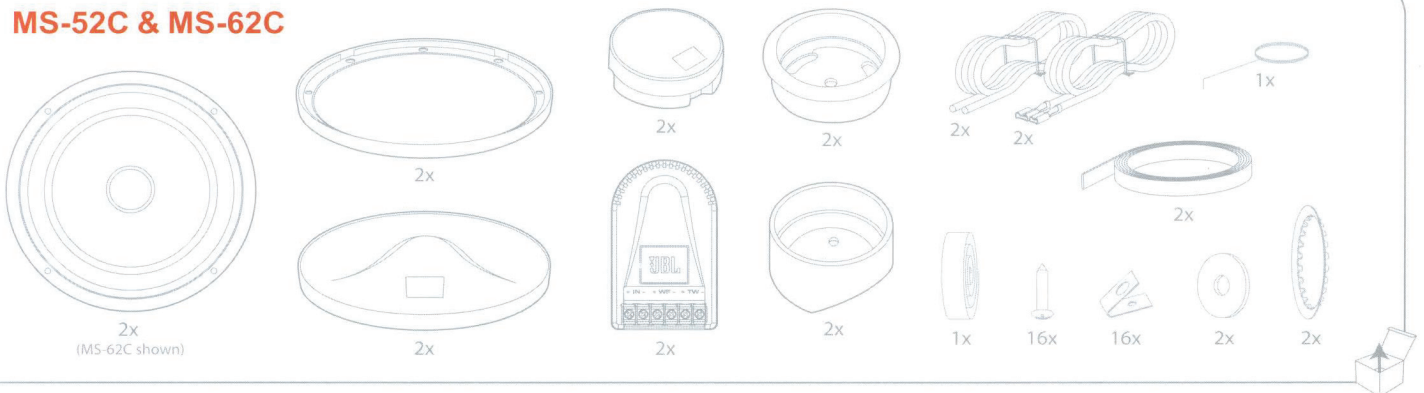

MOUNTING OPTIONS

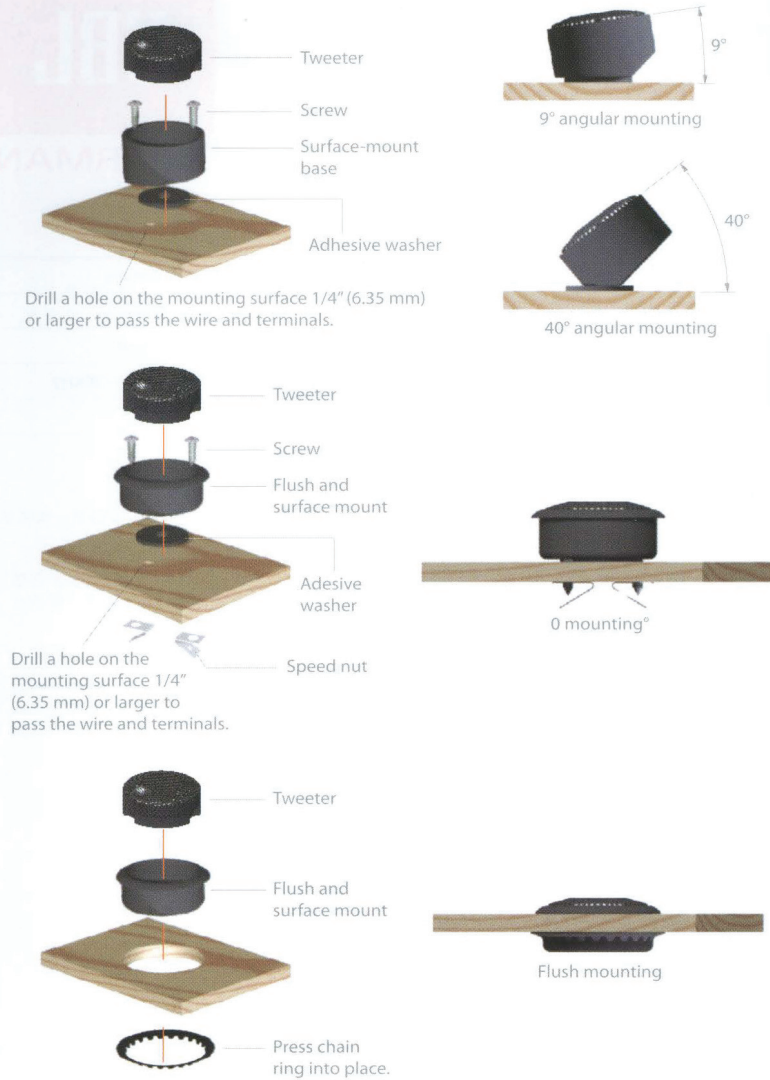

MAKING CONNECTIONS

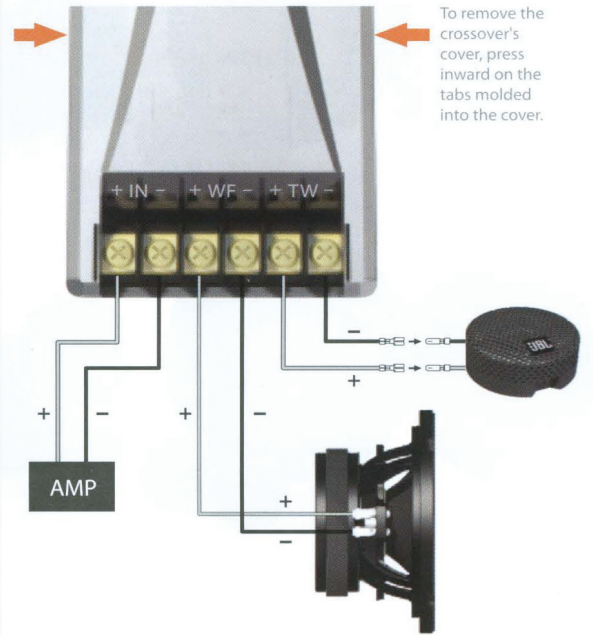

REMOVING THE TWEETER FROM THE MOUNTING BASE

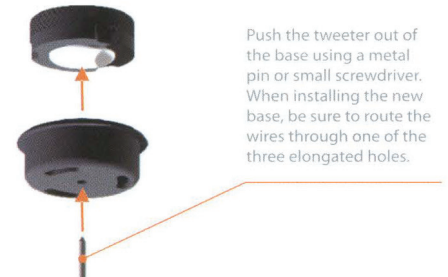

ADJUSTING THE SOUND

ATTENUATION OF THE TWEETER

Adjust the output level of the tweeter to suit your preference according to the illustration below.

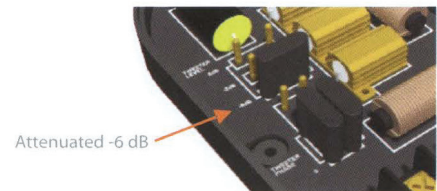
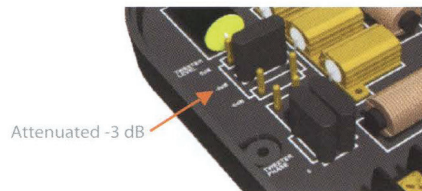
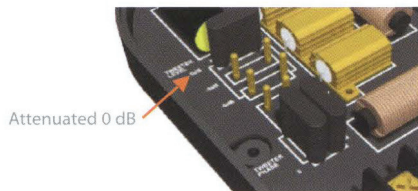

PHASE REVERSAL

Depending on the mounting locations of the woofers and tweeters, it may be desirable to reverse the polarity of the tweeter to provide the best possible blend of sounds from the woofer and tweeter at the crossover frequency. Reverse the polarity of the tweeter using the jumpers marked "phase" in the crossover according to the diagram below.

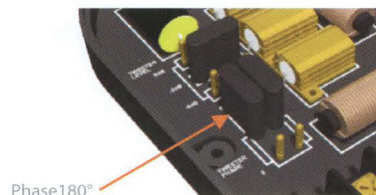
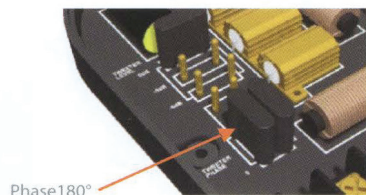

HARMAN Consumer, Inc.
8500 Balboa Boulevard, Northridge, CA 91329 USA

© 2011 HARMAN International Industries, Incorporated. All rights reserved. JBL is a trademark of Harman International Industries, Incorporated, registered in the United States and/or other countries. Features, specifications and appearance are subject to change without notice.

www.jbl.com

Cod.: 053862 Rev.: 04 - 04/10



HARMAN HARMAN Consumer, Inc.
8500 Balboa Boulevard, Northridge, CA 91329 USA

© 2011 HARMAN International Industries, Incorporated. All rights reserved. JBL is a trademark of Harman International Industries, Incorporated, registered in the United States and/or other countries. Features, specifications and appearance are subject to change without notice.

www.jbl.com

Cod.: 053862 Rev.: 05 - 05/10