

2018+ Toyota Camry

Add amplifier(s) to stock stereo - fast & easy!

- No cutting or splicing factory wires!
- No need to run new speaker wires!
- Works with most amplifier brands.
- Works with aftermarket stereos also!

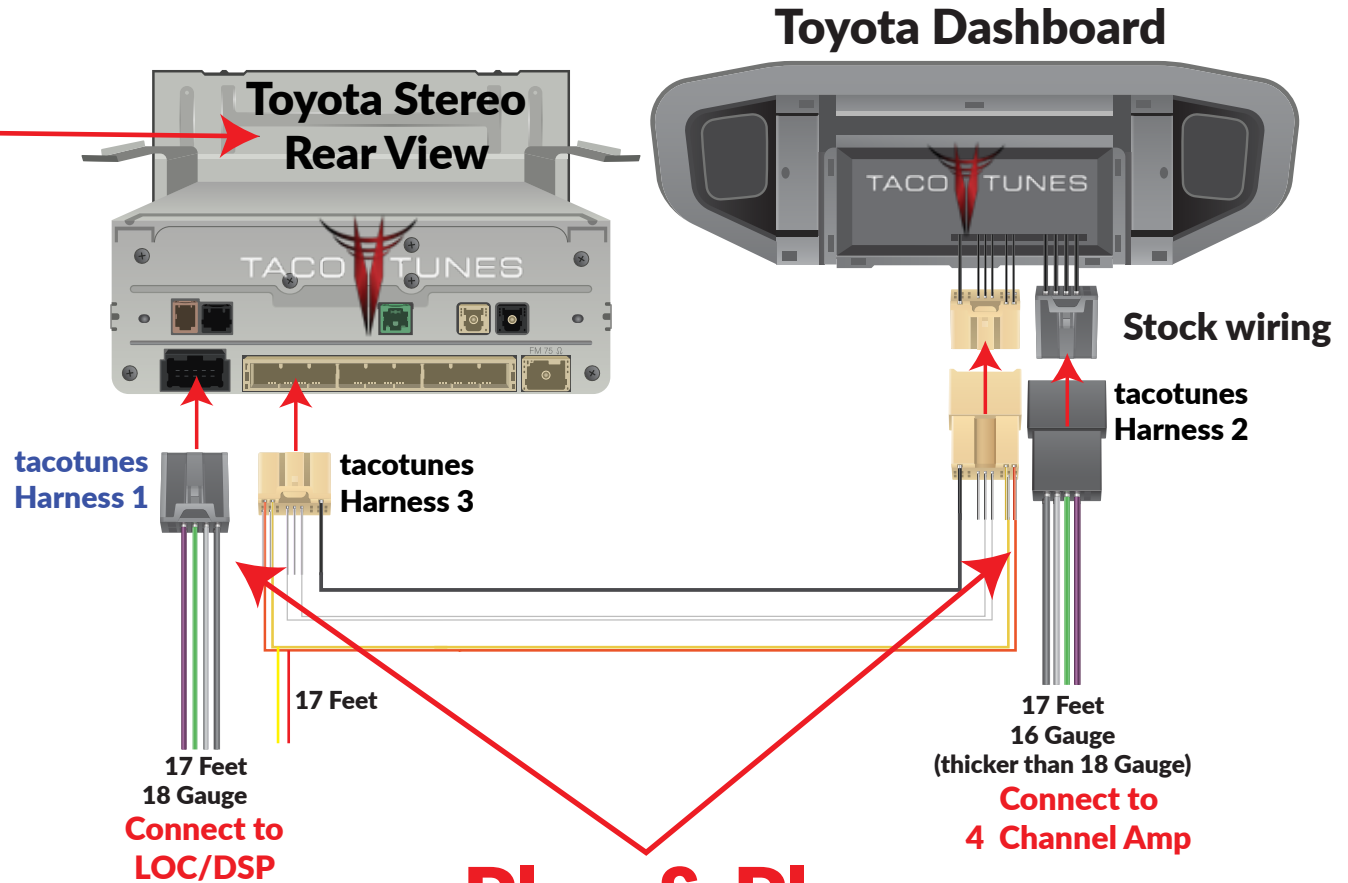

**Plug & Play
Harnesses**



How to connect tacotunes plug & play wiring to: AudioControl LC5i Pro

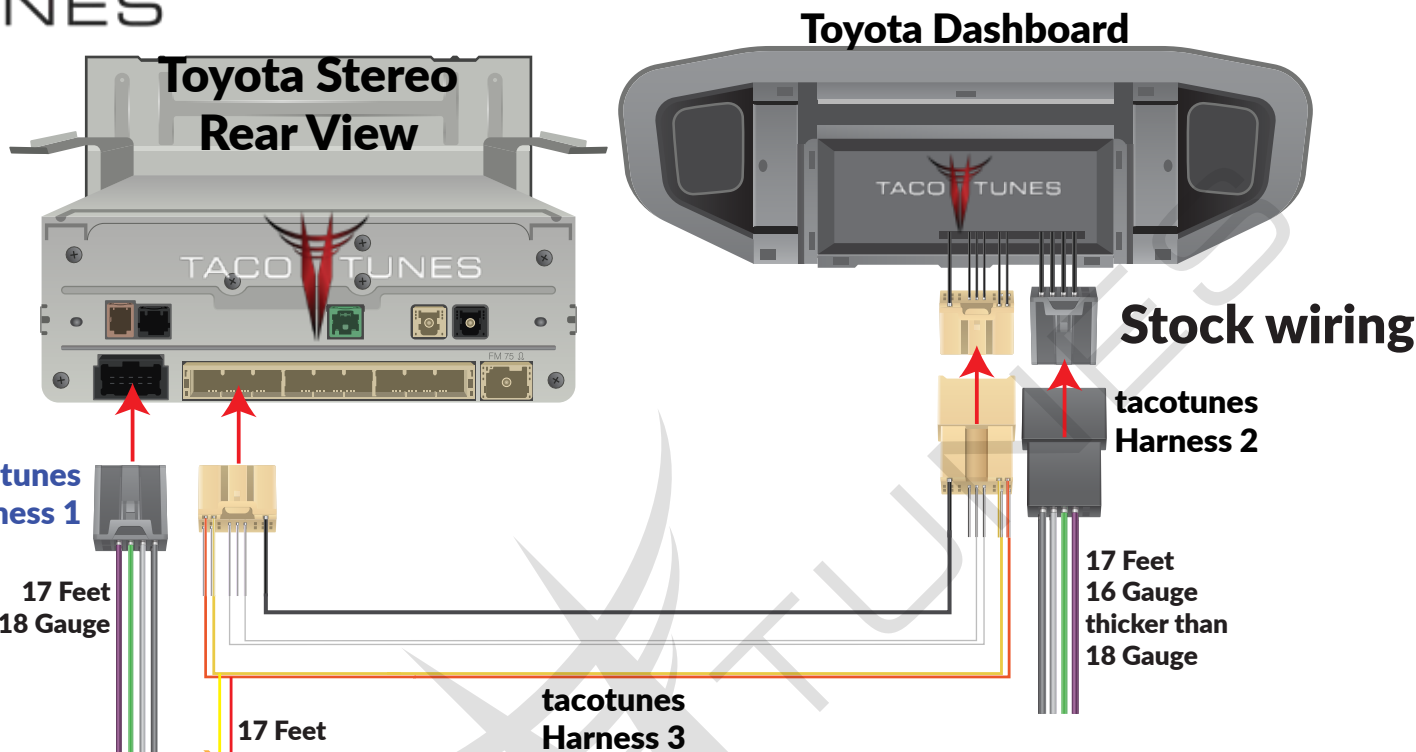

**NOTE: The input / output signal(s) have a few options.
The settings above are summing all channels for full range to
all outputs**

**Connect to LC5i
(Color coded
Installation)**



**Connect to
Amplifier(s)**

How to connect Audio Control LC5i Pro to amplifiers

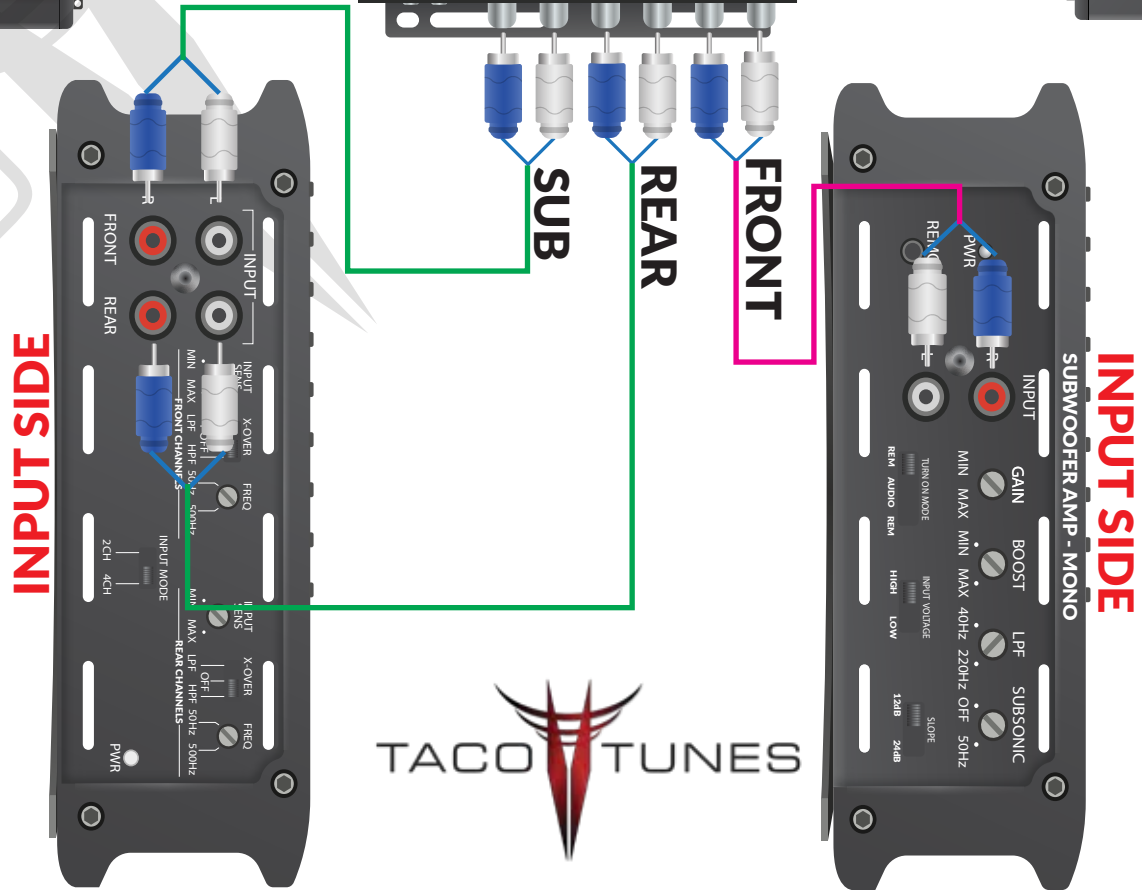

4 Channel & Subwoofer amplifier overview

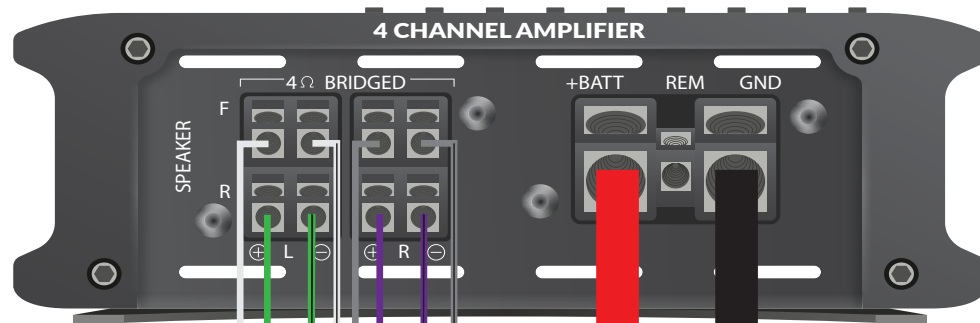
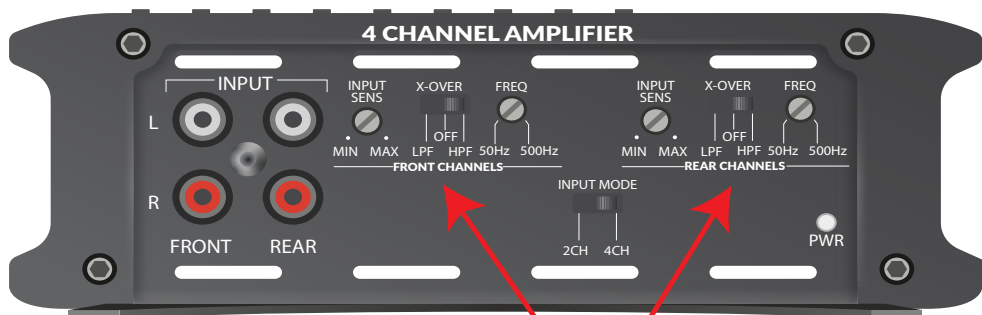

Connect to harness 3.

Power Wire:

From battery / distribution block.
Important: Check with your amp manufacturer
for the proper gauge & fuses

Tuning/Configuration knobs & switches:
Check out our video(s) on how to properly
adjust these settings.

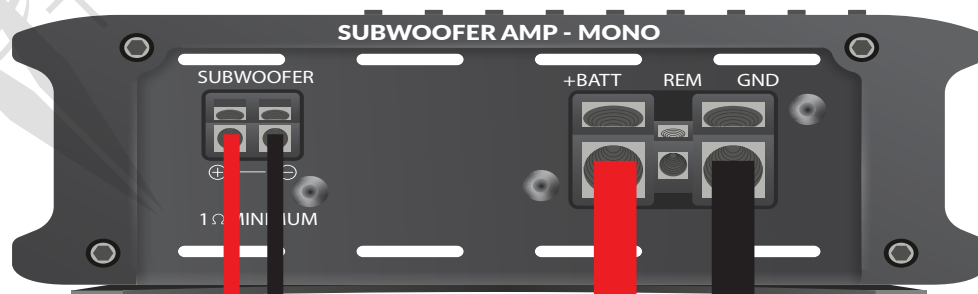

Subwoofer Output

[Link to YouTube Channel](#)

2018+ Toyota Camry

How to add amplifiers to stock stereo in your **Camry** using an LC5i Pro.

Plug and Play, easy install,
no need to run new speaker wire.

Plug & Play Speaker Harnesses next page.

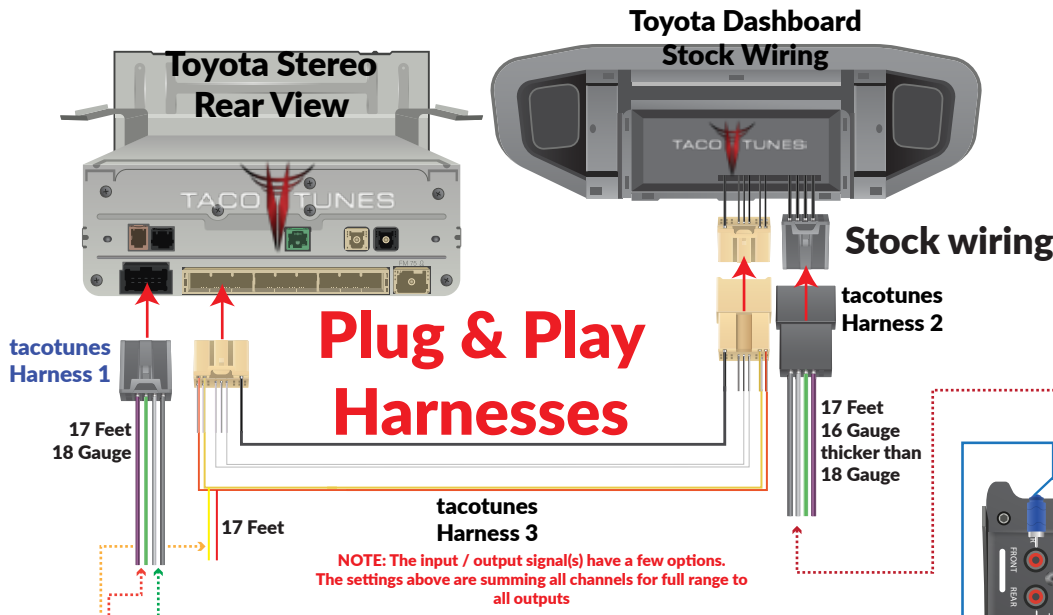

NOTE: The input / output signal(s) have a few options. The settings above are summing all channels for full range to all outputs

NOTE: 100 WATTS RMS X4 MAX POWER - CHECK AMP FOR RMS RATINGS DO NOT USE "PEAK" RATINGS

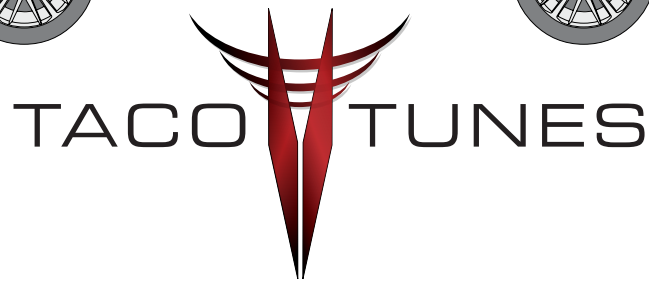
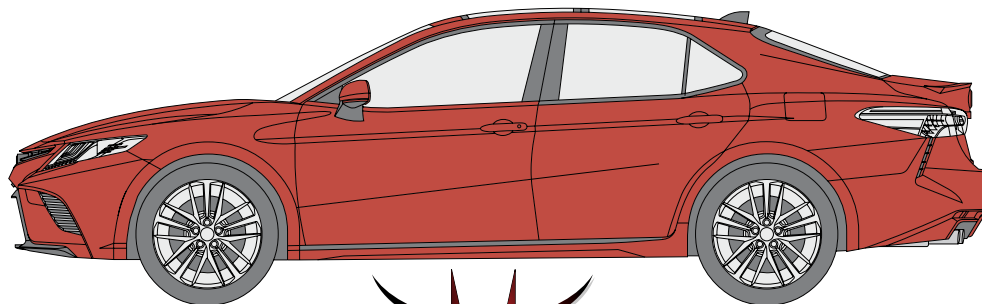
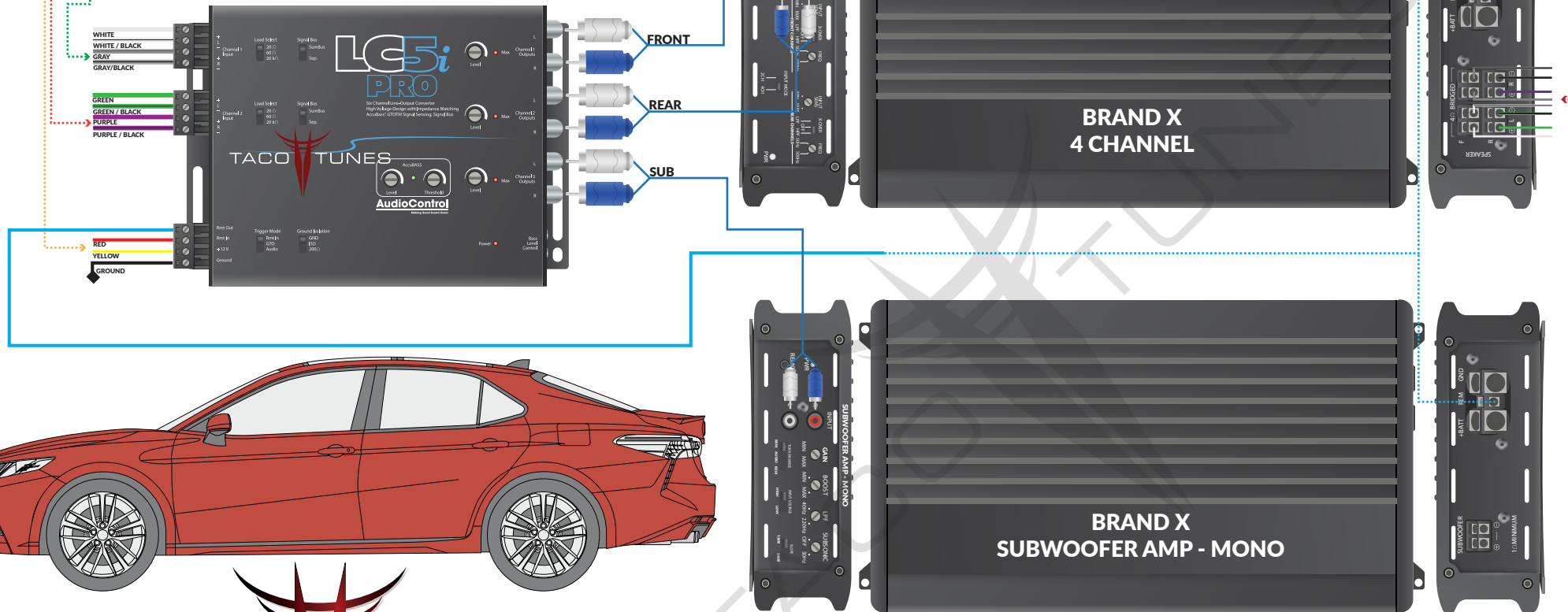

[CLICK HERE FOR HARNESSSES](#)

2018+ Toyota Camry

Stock speaker location overview / plug & play harnesses.

Be sure to check out our video(s) that show you how to easily upgrade the speakers in your **Camry!**

We will explain how your **Camry** is configured from the factory AND show you how to easily upgrade your speakers without any cutting or splicing - ANY of your factory wires!

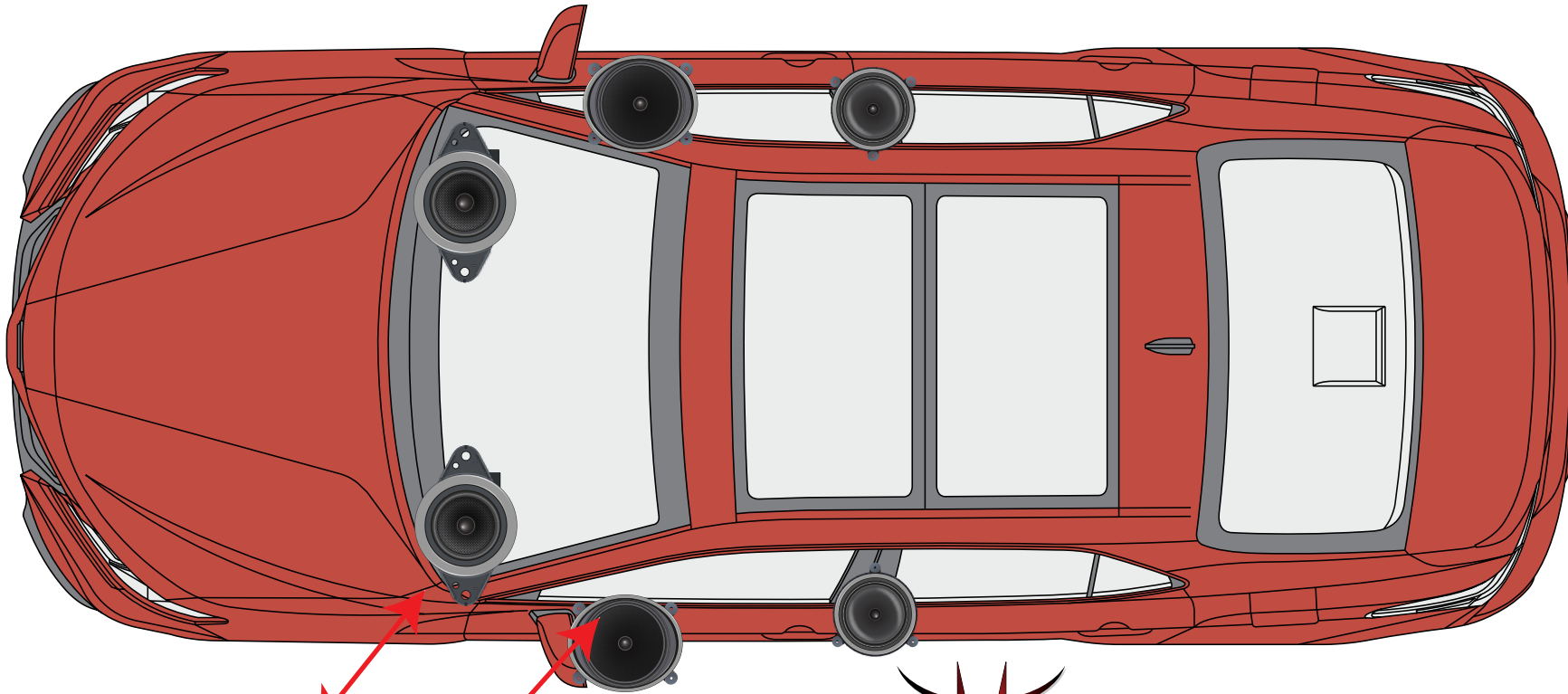

[CLICK HERE](#)
HARNESS A1 HARNESS A2

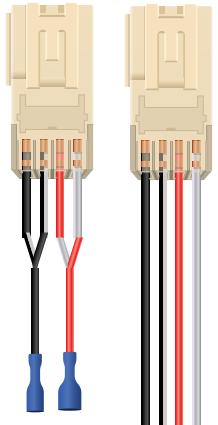

[CLICK HERE](#)
HARNESS A1 HARNESS A2

