

# 2018+ Toyota Sienna

Add amplifier(s) to stock stereo - fast & easy!

- No cutting or splicing factory wires!
- No need to run new speaker wires!
- Works with most amplifier brands.
- Works with aftermarket stereos also!

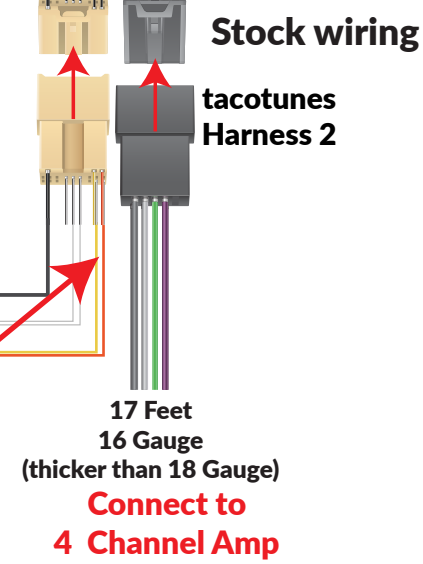
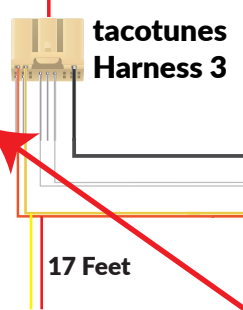
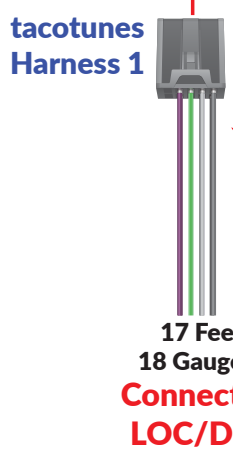

**Plug & Play  
Harnesses**



# How to connect tacotunes plug & play wiring to: AudioControl LC5i Pro

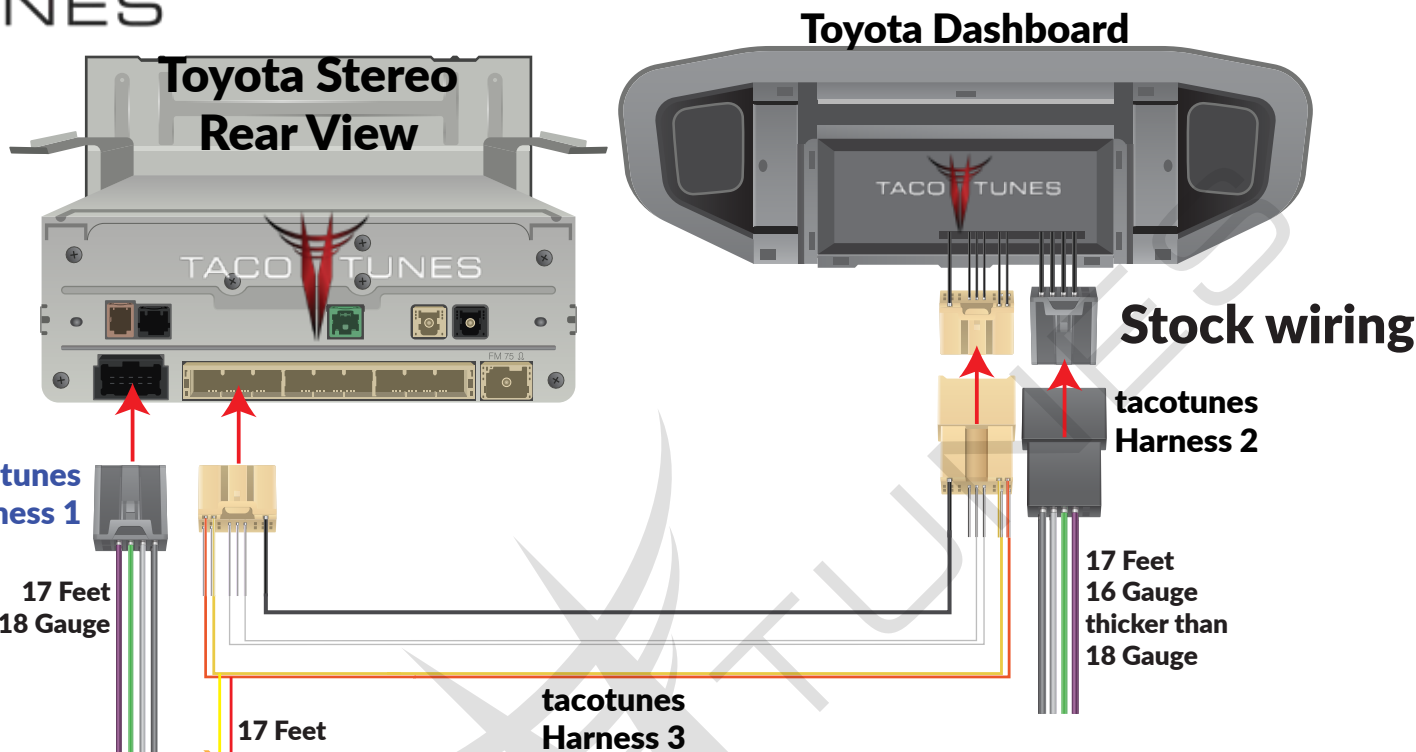

**NOTE: The input / output signal(s) have a few options.  
The settings above are summing all channels for full range to  
all outputs**

**Connect to LC5i  
(Color coded  
Installation)**



**Connect to  
Amplifier(s)**

# How to connect tacotunes LC5I Pro to tacotunes amplifiers



RCA to TXD Connectors, included with NTUNE6

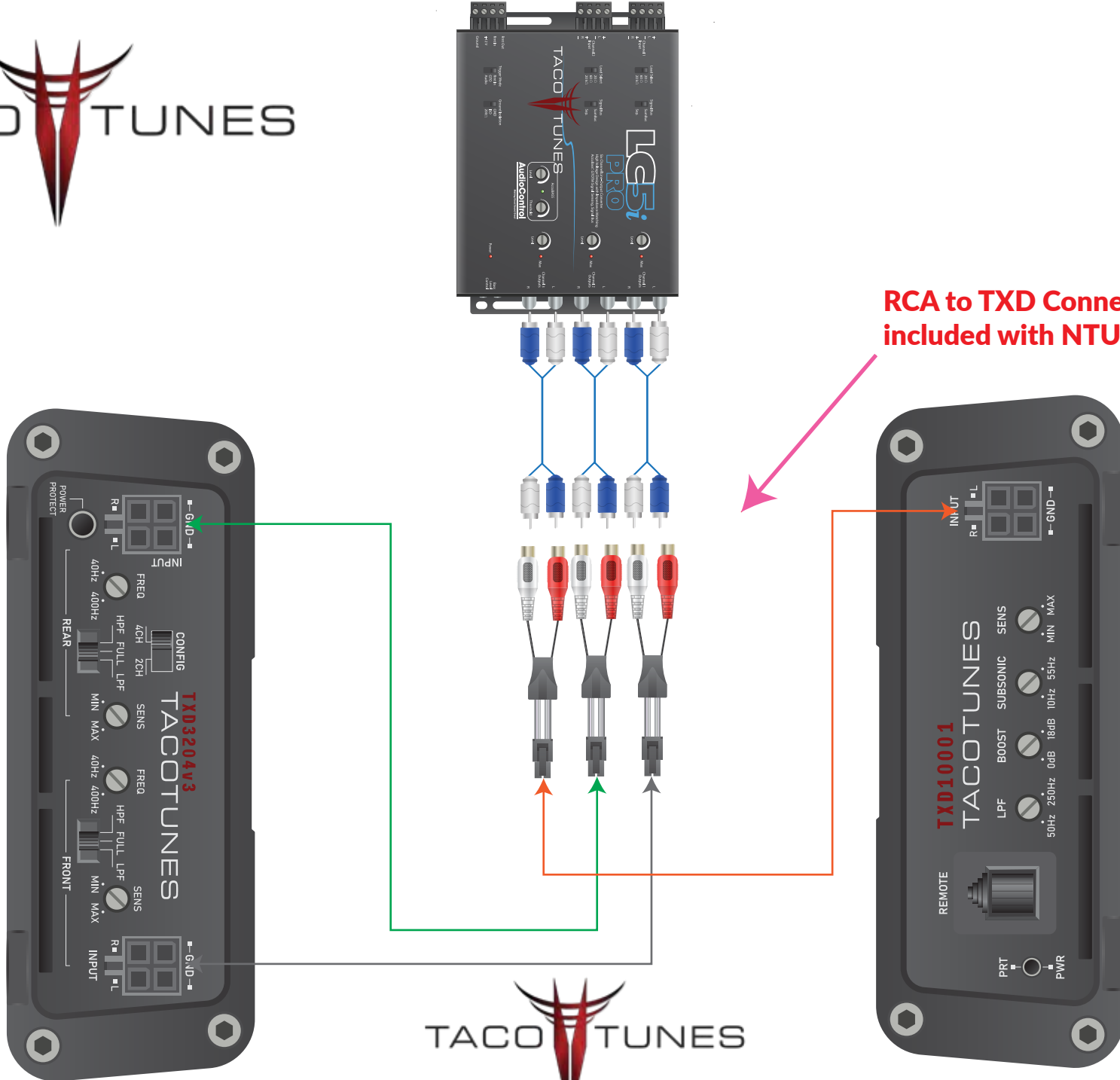
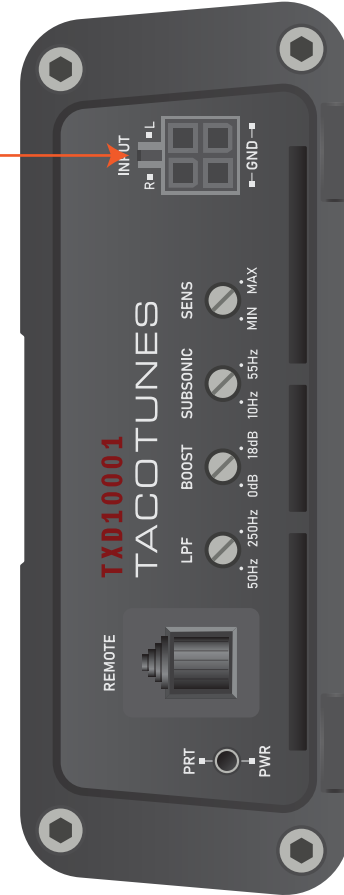
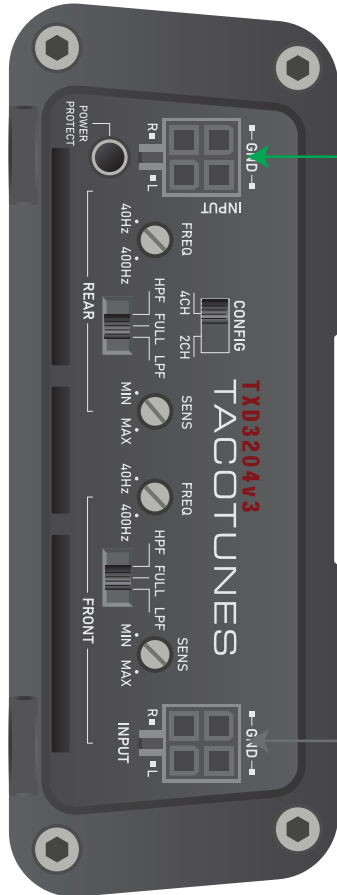

# 4 Channel & Subwoofer amplifier overview

TACOTUNES TXD 4 CHANNEL

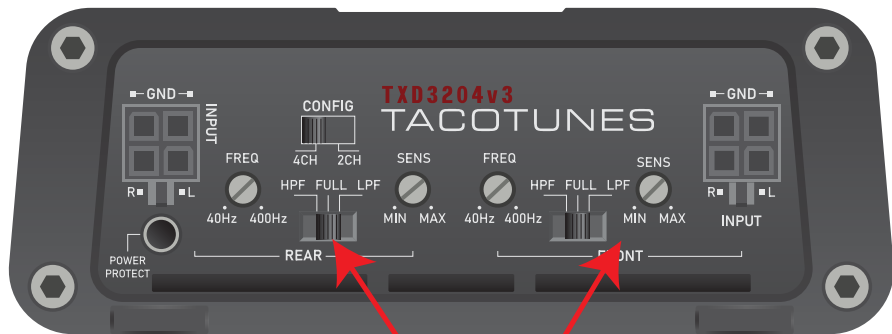

Tuning/Configuration knobs & switches:  
Check out our video(s) on how to properly  
adjust these settings.

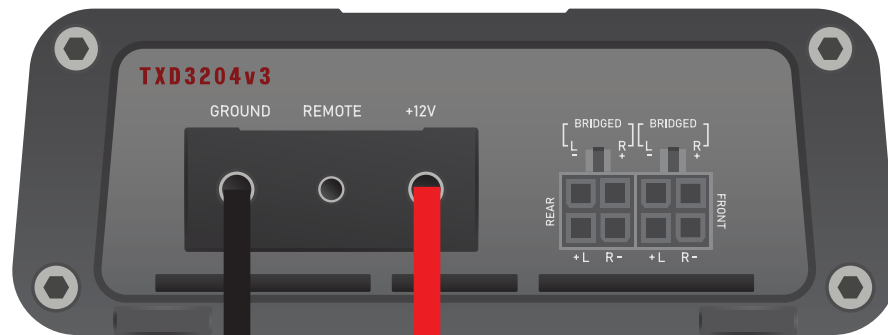

Power Wire:

We offer TXD Amp Kits designed for our TXD  
amps! Check out our website for more info.

Direct Connect  
Molex Plugs



TACOTUNES TXD SUBWOOFER AMP



Subwoofer Output

[Link to YouTube Channel](#)



# 2018+ Toyota Sienna

Stock speaker location overview / plug & play harnesses.

Be sure to check out our video(s) that show you how to easily upgrade the speakers in your **Sienna**!

We will explain how your **Sienna** is configured from the factory AND show you how to easily upgrade your speakers without any cutting or splicing - ANY of your factory wires!

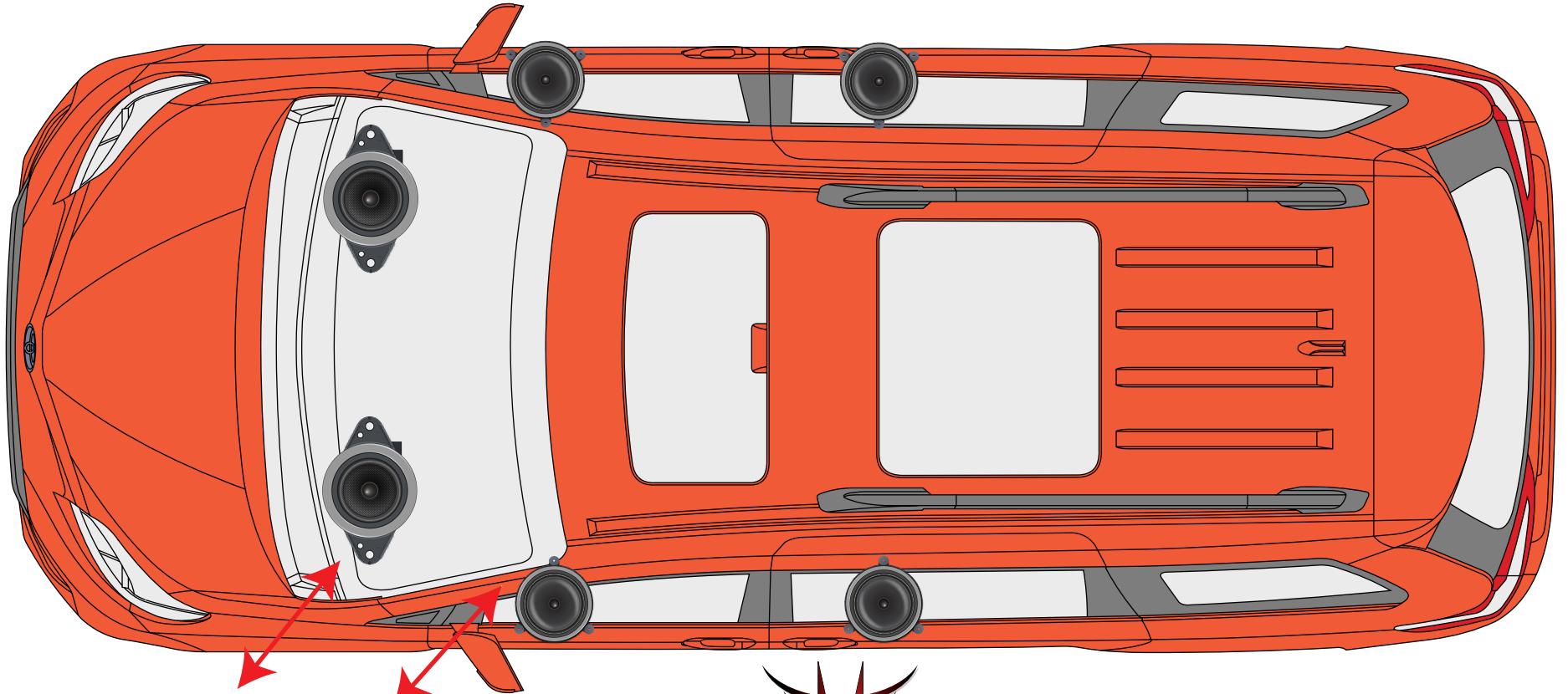

[CLICK HERE](#)  
HARNESS A1 HARNESS A2

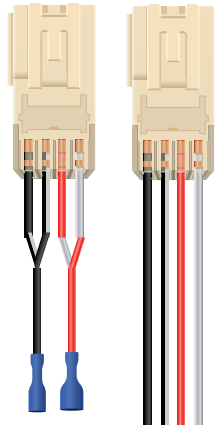

[CLICK HERE](#)  
HARNESS A1 HARNESS A2

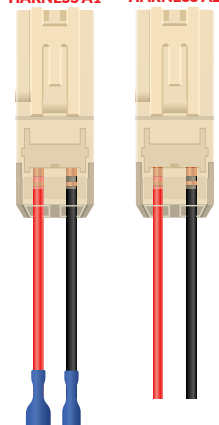

TACO TUNES

