

2020+ Toyota Tacoma

Add Subwoofer(s) to stock stereo -
mono subwoofer amplifier installation diagrams.

- No cutting or splicing factory wires!
- Works with most amplifier brands.

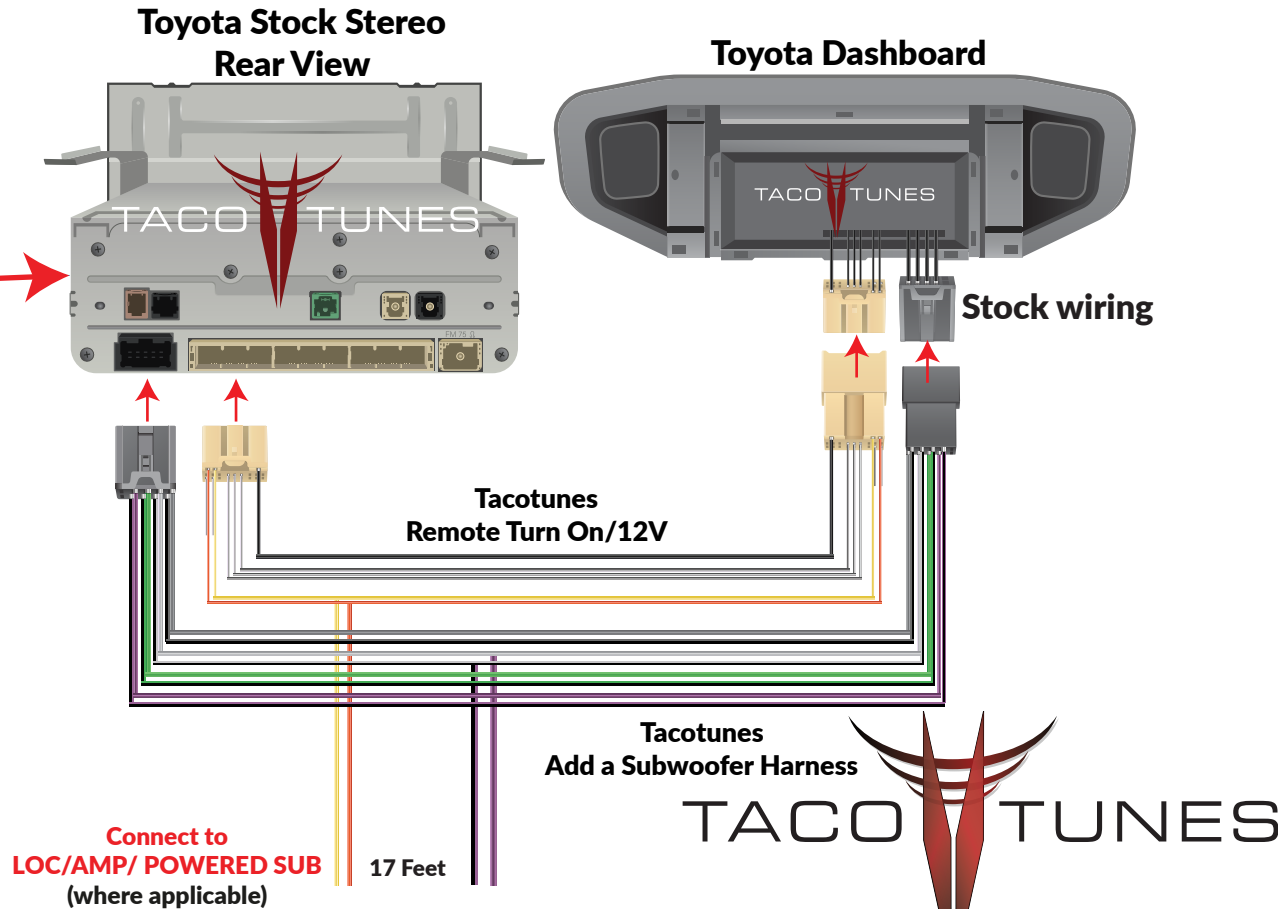
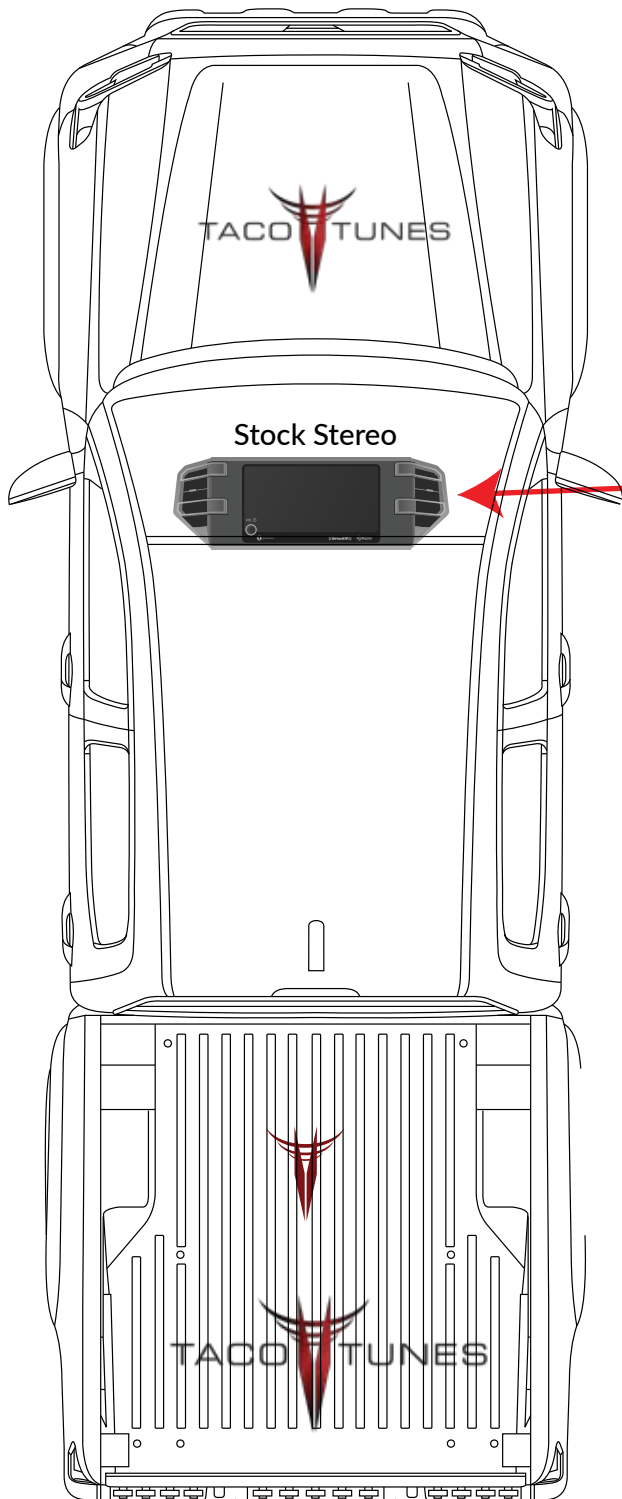

[CLICK HERE](#)
Plug & Play Harnesses

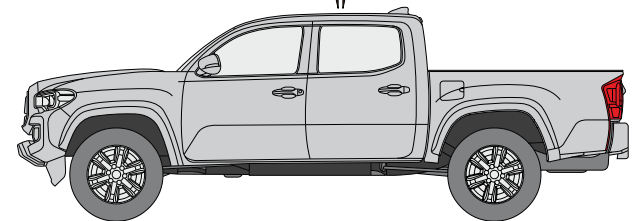

Example 1A:
Mono amp with high level input & autostart

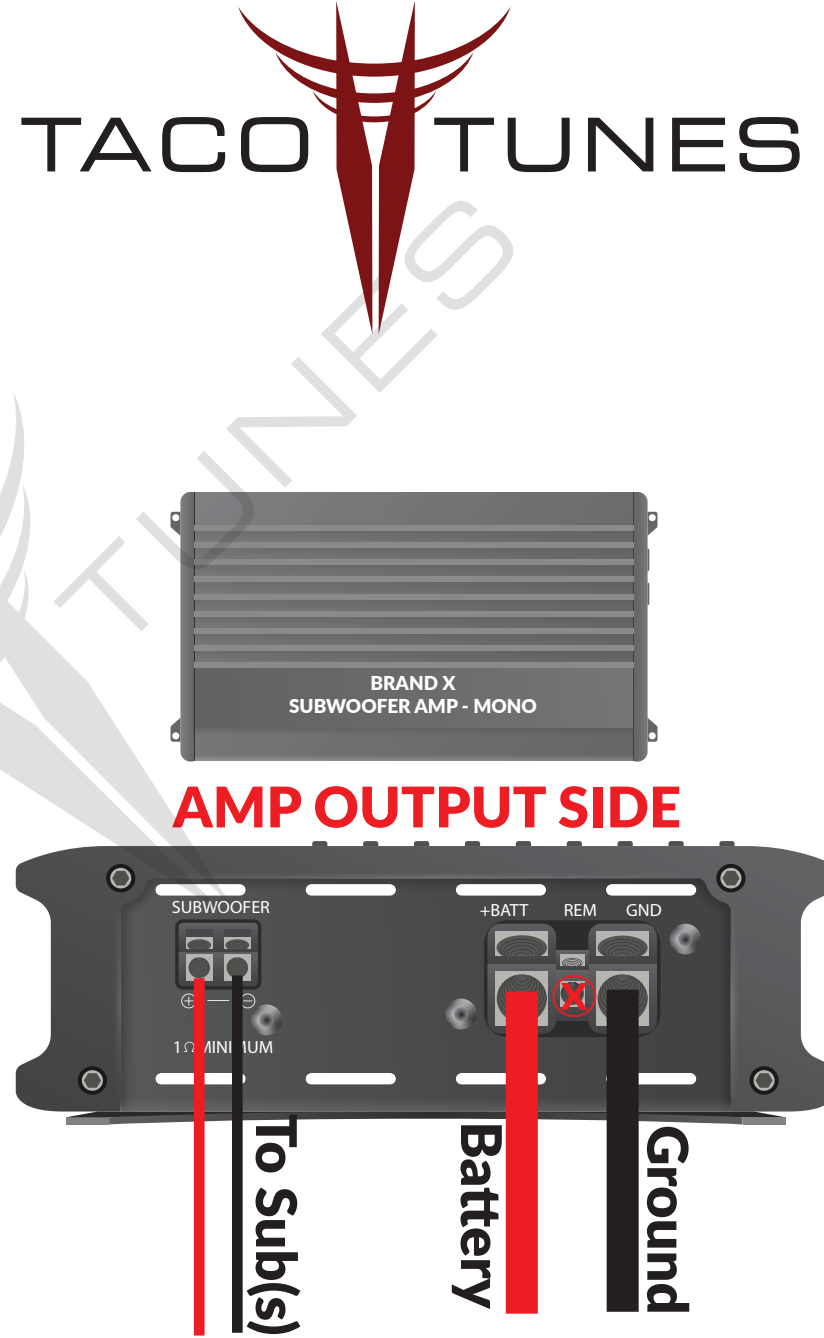
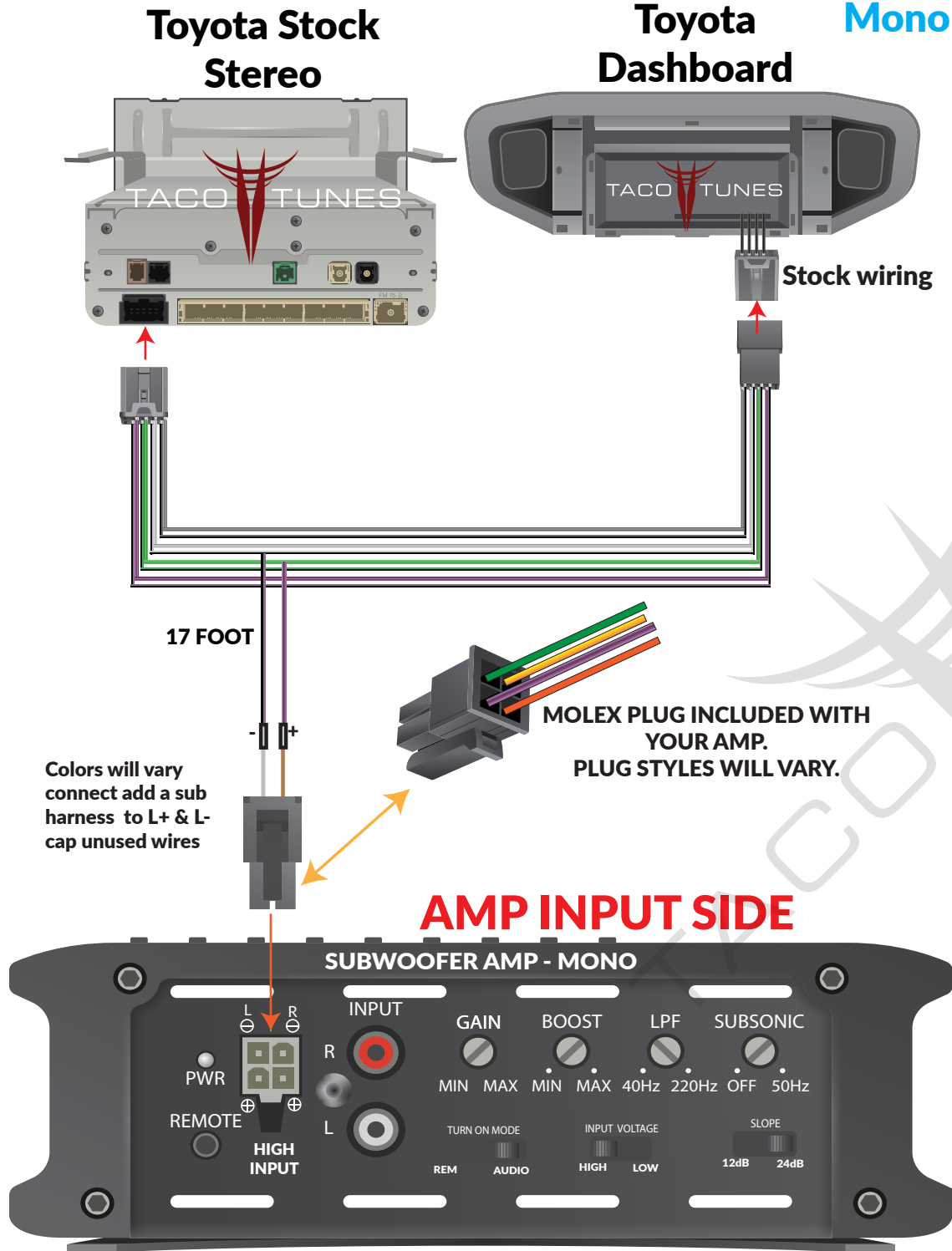

Example 1B:

Mono amp with high level input & autostart

Toyota Stock Stereo

Toyota Dashboard

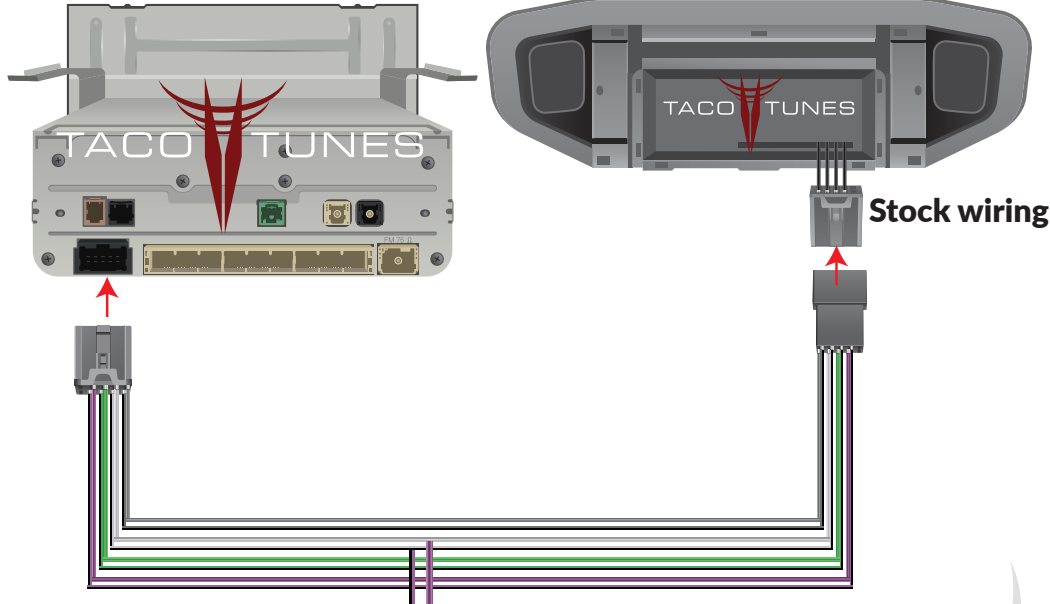

17 FOOT

High Level to RCA
Available on our website.

AMP INPUT SIDE

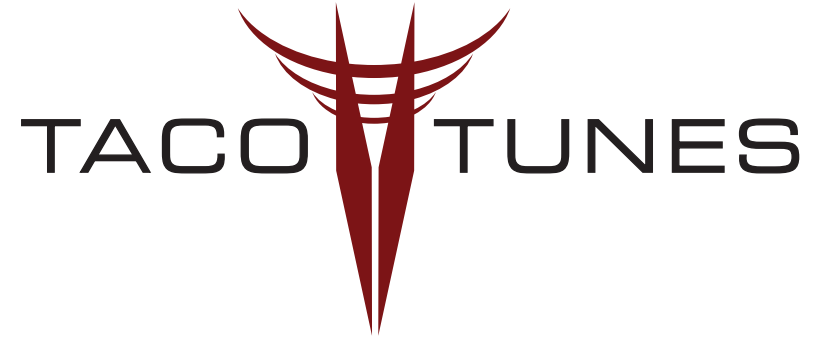

AMP OUTPUT SIDE

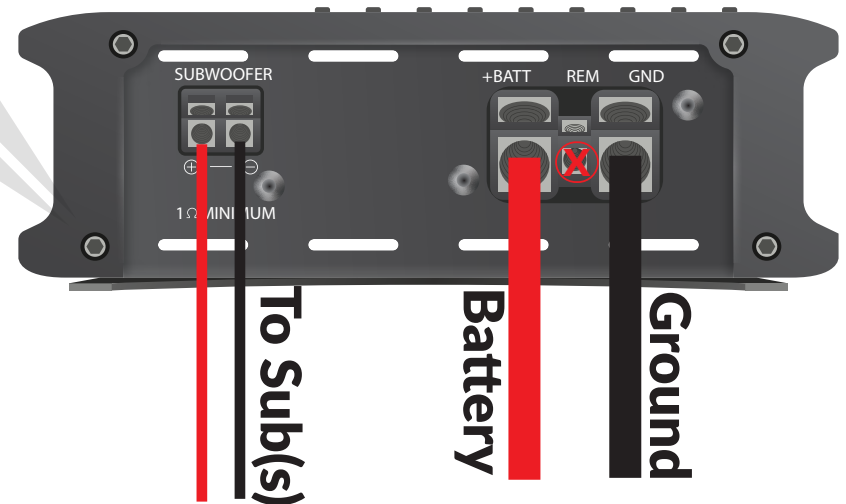

Toyota Stock Stereo Rear View

Toyota Dashboard

Example 2A: Mono amp with low level input Audio Control LC2i Pro

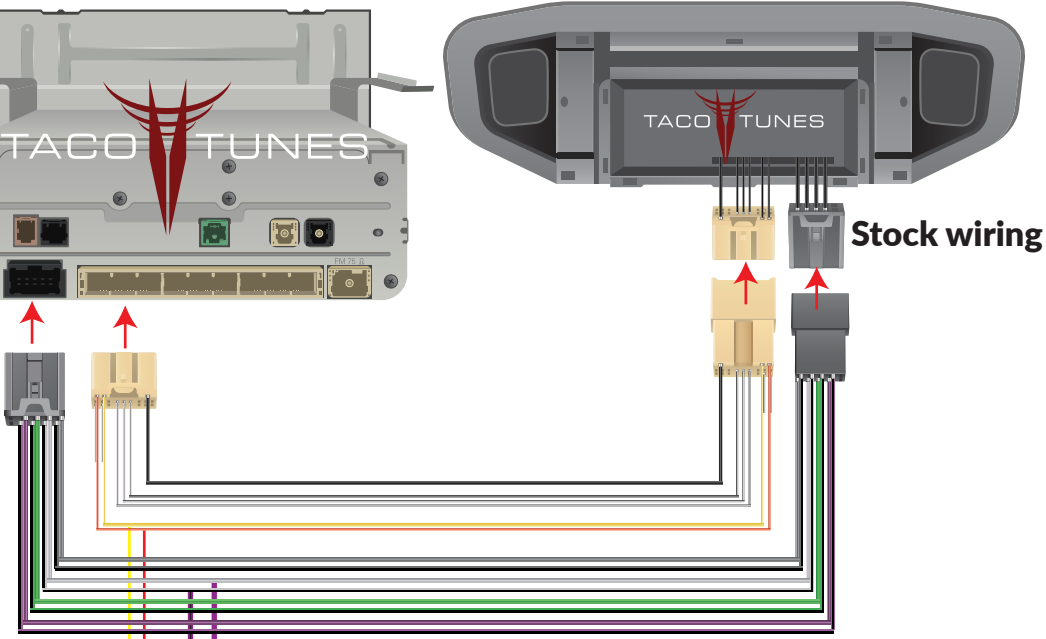

AMP OUTPUT SIDE

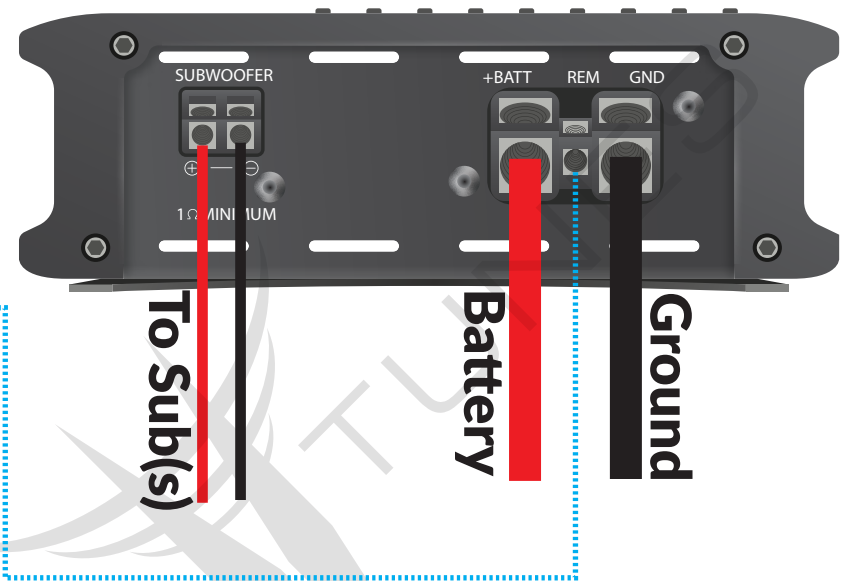

AMP INPUT SIDE

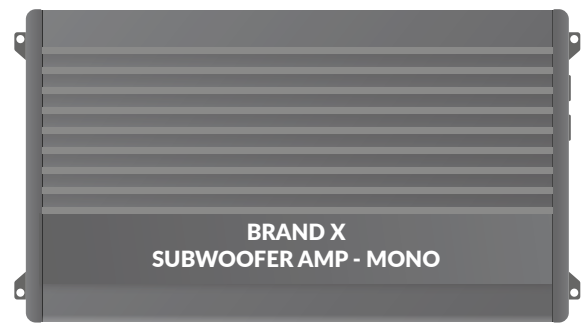

Toyota Stock Stereo Rear View

Toyota Dashboard

Example 2B: Mono amp with low level input Powered Line Out Converter (LOC)

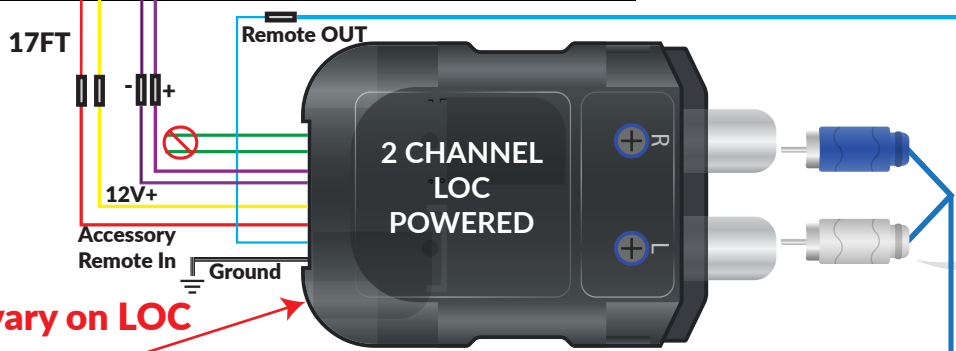
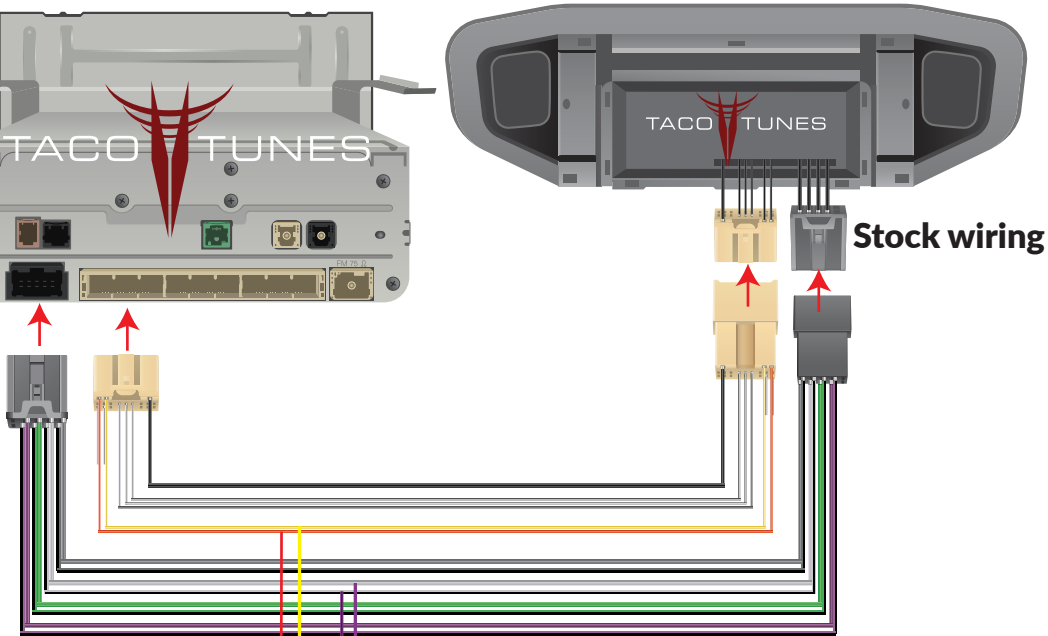
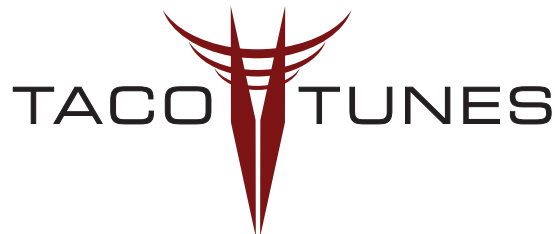

Colors may vary on LOC
Connect purple wires from harness to L+ & L-.

AMP OUTPUT SIDE

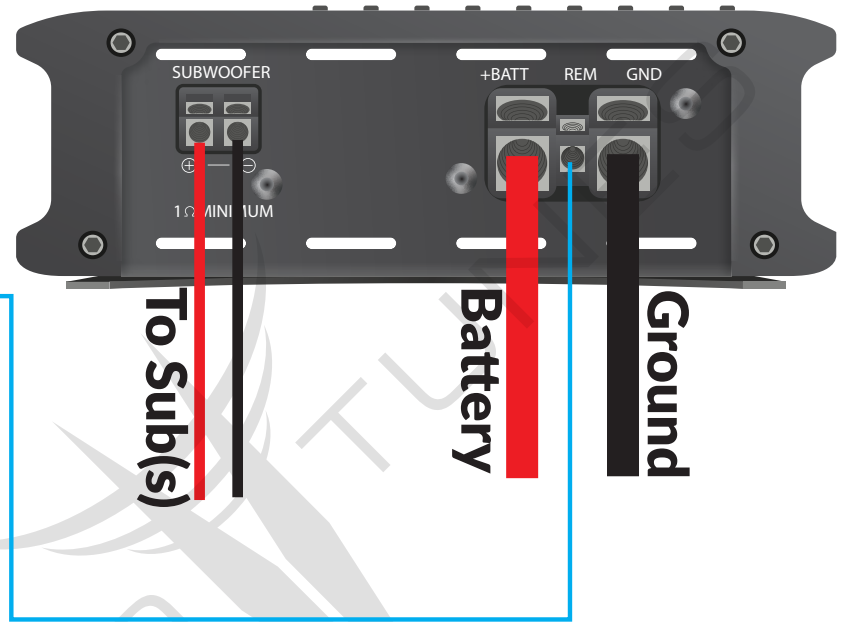

To Sub(s)
Battery
Ground

AMP INPUT SIDE

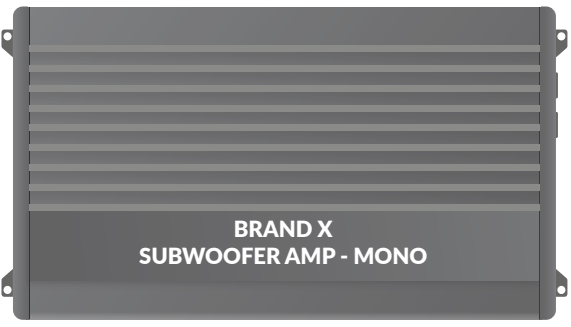

Example Subwoofer amplifier.

[Click here for notes on how to setup your amplifier and a list of FAQ.](#)

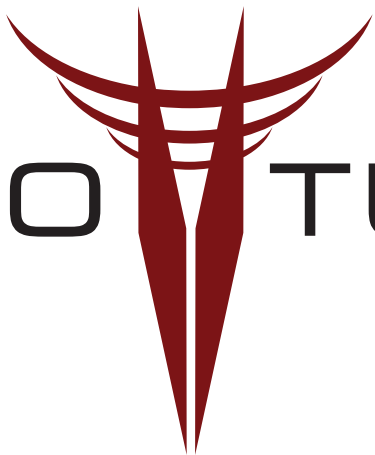

TACO  TUNES